

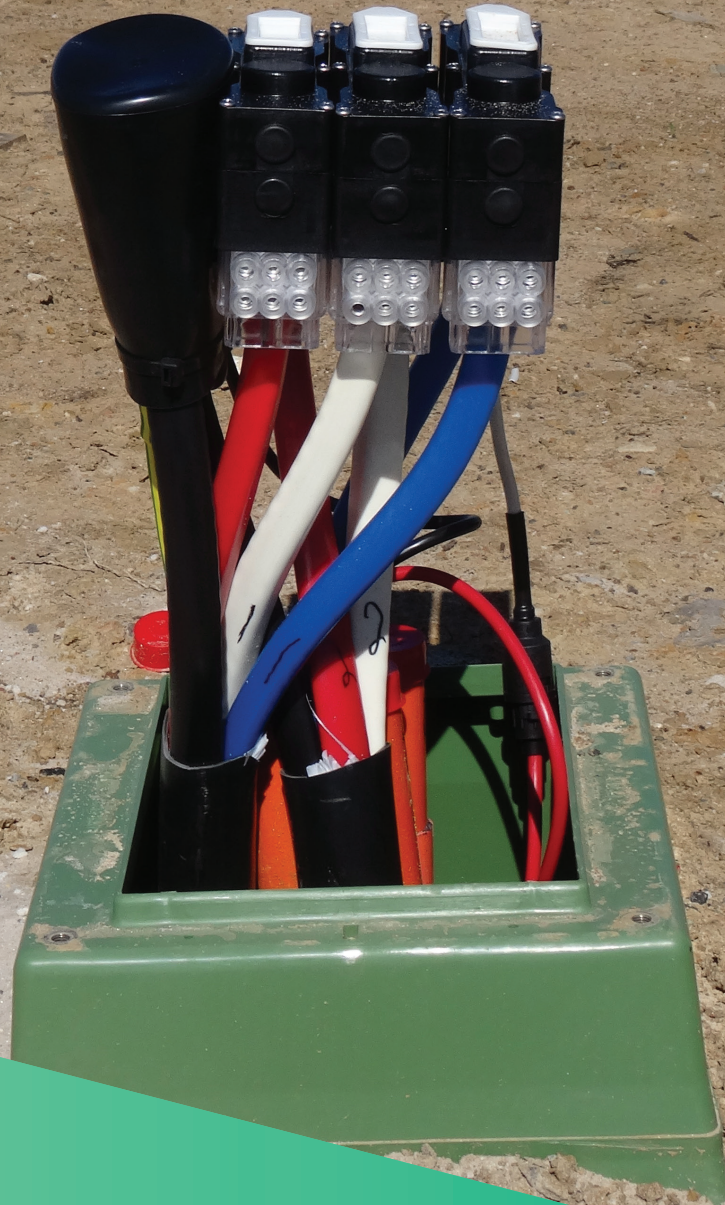

All Round
Supplies



Endeavour Energy

Low Voltage Underground

Version 2

What we do



Wholesale

Wholesale supply of a comprehensive range of products for the electrical/energy industry, including exclusive items. (Did we mention competitive prices?)



Online and over-the-phone order

Buy common-use/day-to-day items online and over the phone.



Expert assistance

You can call up and speak with a salesperson who understands your industry.



Full-scale project quotes

We also do in-depth quotes on full-scale projects/tenders.

CONTENTS:

Cable & heatshrink	06
Sealing/end-capping cables	06
UG/OH constructions	07
Quick reference tables	08
Pillars	10
Numbers and labels	11
Kiosk terminations	12
Joints	12



**Heatshrink
Joints**



**Resin
Joints**



REFER TO
OUR MV
UNDERGROUND
BROCHURE

REFER TO
OUR KIOSK
SUBSTATIONS
BROCHURE

**UG/OH
Constructions**
Page 7

**KIOSK
terminations**
Page 12

Joints
Page 12

Pillars
Page 10

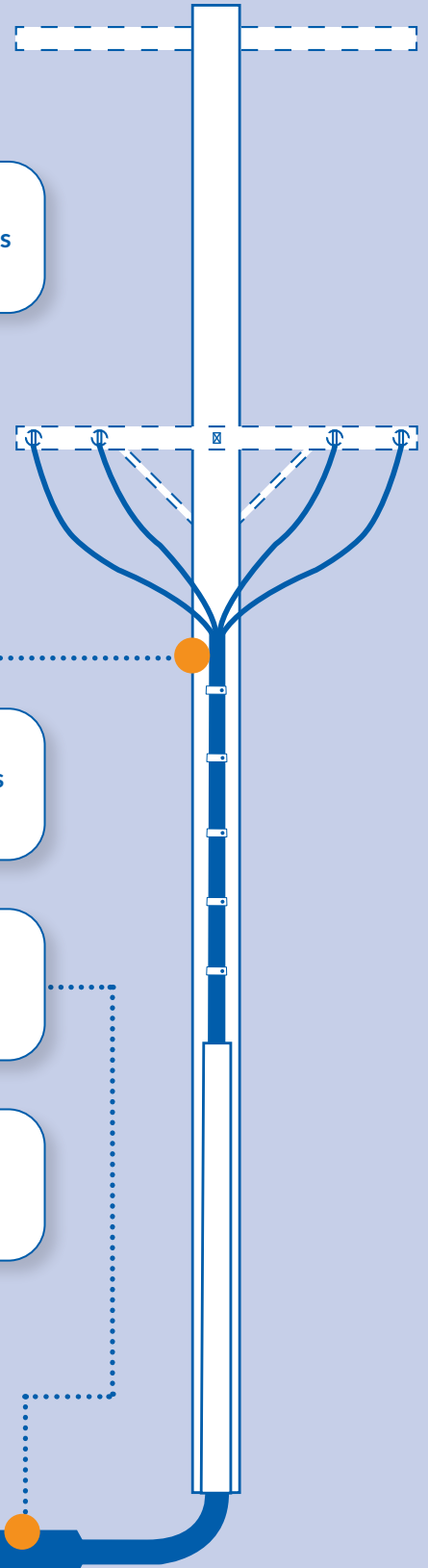

Cable

Cable – LV Underground

Description	Pack Size	MOQ Cut	Cut Fee	ARS Code
LV 4c 240mm ² stranded AL XLPE/PVC	Full drums only (600m)	N/A	N/A	00046
	Full drums only (600/1000m)	N/A	N/A	00046N
	Cuts only (CTL)	50M	\$85.00	00046CTL
LV 4c 50mm ² CU XLPE/PVC	Full drums only (100m)	N/A	N/A	00111N
	Cut in house (max 30m)	1M	\$0.00	00111C
LV 2c 16mm ² CU XLPE/PVC	Full drums only (100m)	N/A	N/A	00681N
	Full drums only (300m)	N/A	N/A	06864
	Full drums only (500m)	N/A	N/A	07314
LV 2c 16mm ² CU XLPE/PVC	Full drums only (175m)	N/A	N/A	06673N
	Full drums only (500m)	N/A	N/A	06790N
LV 2c 2.5mm ² CU XLPE/PVC	Full drums only (100m)	N/A	N/A	06273

Cable sealing components

Description	Unit of Measure	ARS Code
Copper ID tag for underground cable	Pack of 100	08712
Wire, fuse 80Amp – 1.63mm	Coil 0.5kg	03793
Clout, 2.8mm x 40mm – galvanised	2kg tub	00496

Typical cable sealing details:

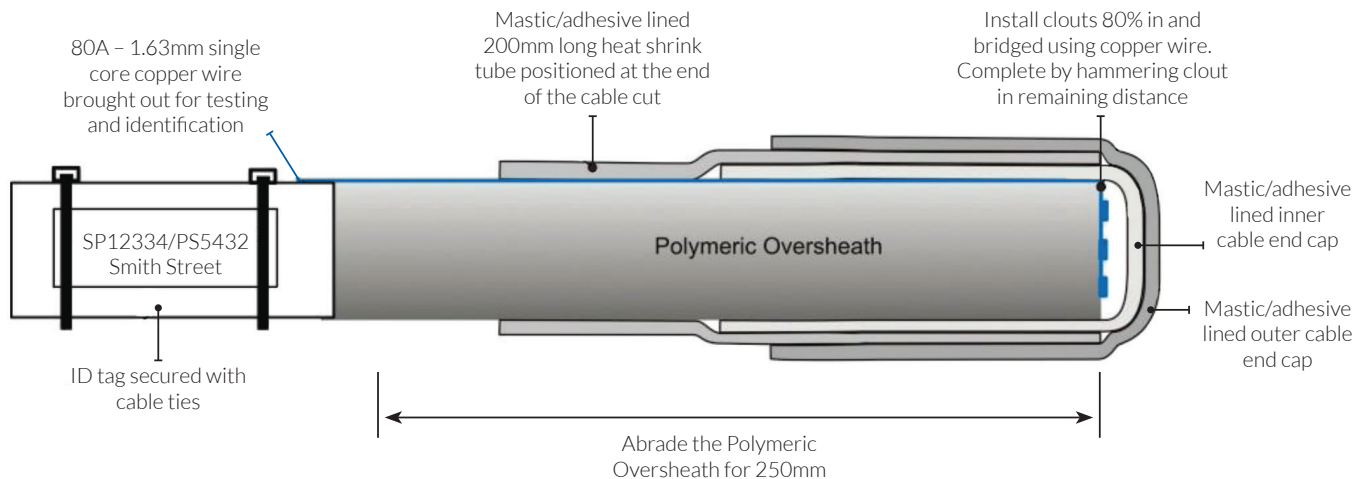

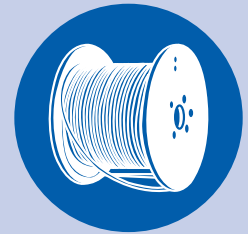

Heatshrink End Caps – Adhesive Lined



Description	Unit of Measure	ARS Code
4-8 OD BLK LIN	Each	04072
8-17 OD BLK LIN	Each	02646
17-30 OD BLK LIN	Each	02194
30-45 OD BLK LIN	Each	02422
45- 65 OD BLK LIN	Each	00197
65-95 OD BLK LIN	Each	02496
95-115 OD BLK LIN	Each	05034

Heatshrink Tubing – Adhesive Lined



Description	Unit of Measure	ARS Code
LV 35/12MW black lined	1.2m length	00318
LV 50/16MW black lined	1.2m length	00129
LV 63/19MW black lined	1.2m length	00547
LV 140/42MW black lined	1.5m length	04892

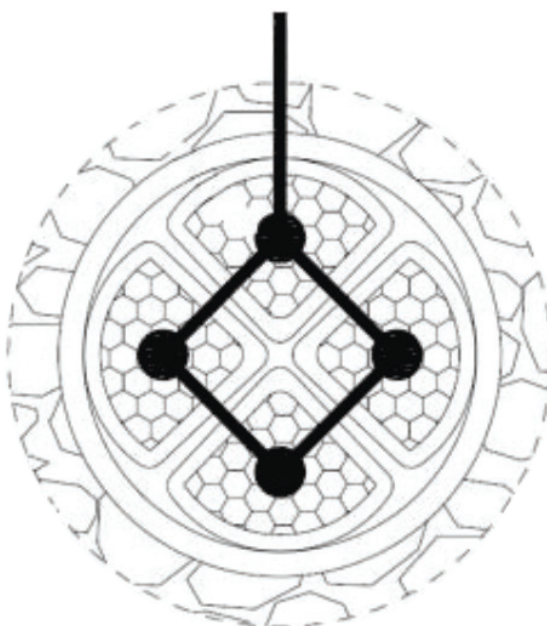

End view of cable cores bridged together

SEALING AND END-CAPPING OF CABLES

For unterminated underground cables, including the balance of the cables on cable drums, the cables must be sealed at both ends to prevent the ingress of moisture into the cable before, during and after installation.

Where multi-core cables are installed and the cable end is to be buried, or not terminated immediately, the cable cores shall be bridged prior to sealing and identification tagged. The single solid core wire tail brought out of the sealed end is to assist identification and is not designed to withstand a fault current.

As a minimum, cable sealing will now be achieved through the method detailed in MCI 0006 clause 3.4.4.

UGOH Constructions

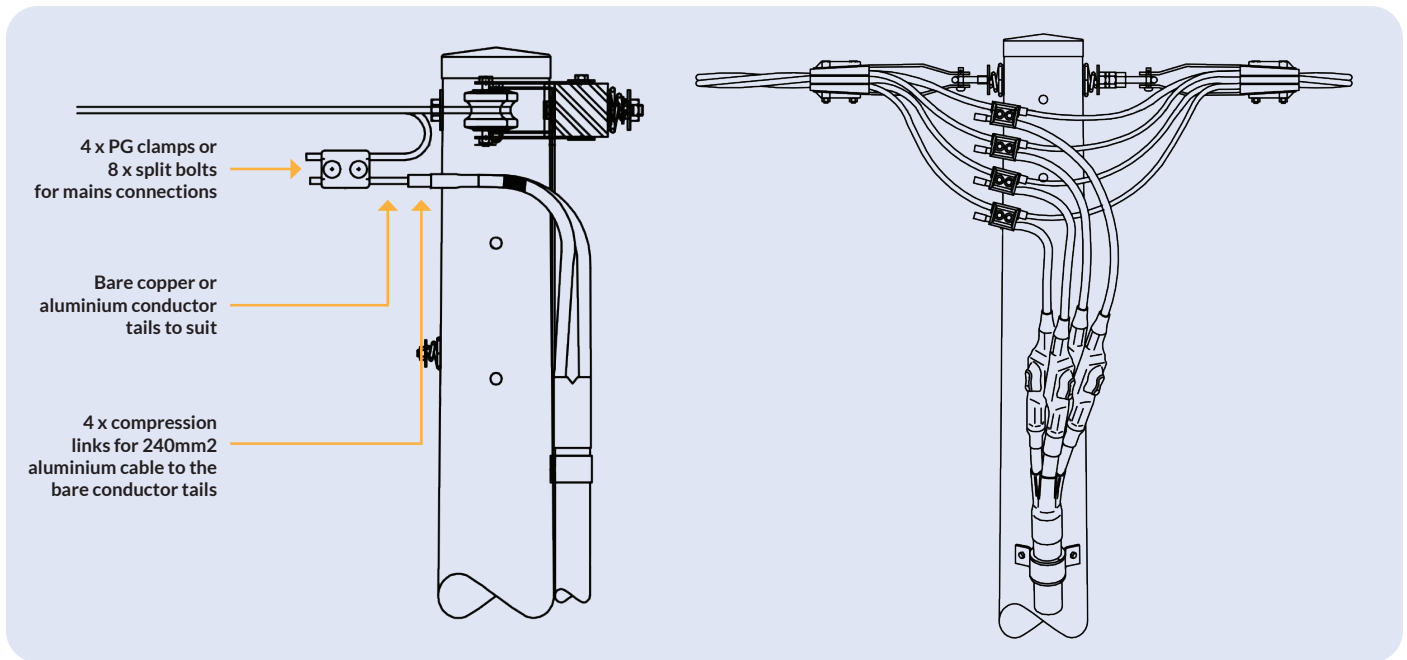

UG/OH Construction to ABC Mains



Description	Unit of Measure	ARS Code
ENDLUGOH (4C 240 AL XLPE TO 95 ABC WOOD) - includes LV ABC dropper cable	Kit	A0037
ENDLUGOH (4C 240 AL XLPE TO 95 ABC NT W) - excludes LV ABC dropper cable	Kit	A0069
ENDLUGOH (4C 240 AL XLPE TO 2 X 95 ABC W) - includes LV ABC dropper cable	Kit	A0935
ENDLUGOH (4C 240 AL XLPE TO 150 ABC WOOD) - includes LV ABC dropper cable	Kit	A0351
ENDLUGOH (4C 240 AL XLPE TO 150 ABC NT W) - excludes LV ABC dropper cable	Kit	A0720

UG/OH Construction to Bare Mains



Description	Unit of Measure	ARS Code
ENDLUGOH (4C 240 AL XLPE NO BONDING WOOD)	Kit	A0618
ENDLUGOH (4C 240 AL XLPE 19/3.75 AL W)	Kit	A3674

Pillars

URD Service Pillar

Description	Unit of Measure	ARS Code
ENDLVPILLAR, 4C 50 CU - Service	Kit	A1070

URD Mains Pillars

Description	Unit of Measure	ARS Code
ENDLVPILLAR, 4C 240 AL - 1 MAINS	Kit	A1056
ENDLVPILLAR, 4C 240 AL - 2 MAINS	Kit	A1057
ENDLVPILLAR, 4C 240 AL - 3 MAINS	Kit	A1058

URD Link Pillars

Description	Unit of Measure	ARS Code
ENDLVPILLAR, 4C 240 AL - 2 WAY SGL LINK	Kit	A1059
ENDLVPILLAR, 4C 240 AL-3 WAY TRP LINK RES	Kit	A1229
SUPPORT KIT, 3-WAY TRIPLE LINK TERM	Set	09166

UID Pillar

Description	Unit of Measure	ARS Code
ENDLVPILLAR, 4C 240 AL - 3 WAY LINK C/I	Kit	A1061

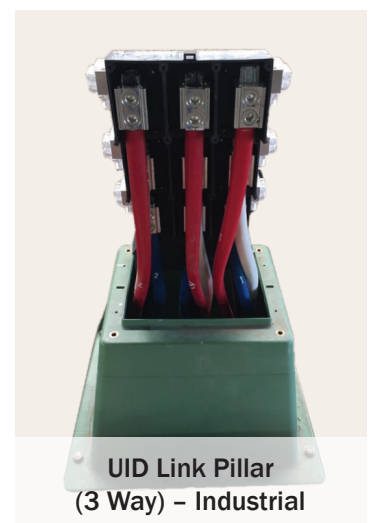
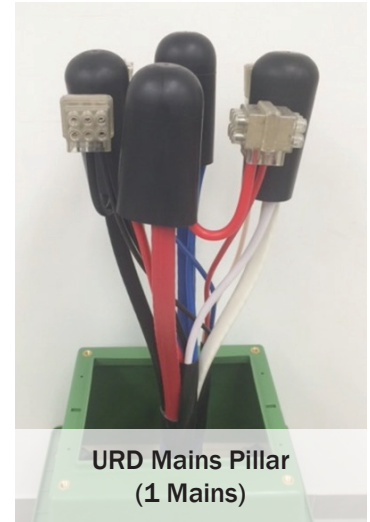

Labels

Numerals

Sheet of 30 adhesive-backed, stick-on labels, black on white

Number	ARS Code	Number	ARS Code	Number	ARS Code
0	00206	4	00200	8	00204
1	00164	5	00201	9	00202
2	00198	6	00202		
3	00199	7	00203		



Letters

Sheet of 30 adhesive-backed, stick-on labels, black on white

Letter	ARS Code	Letter	ARS Code	Letter	ARS Code
A	00205	J	02239	S	02736
B	00210	K	02240	T	02247
C	02232	L	02241	U	02248
D	02233	M	06908	V	02249
E	02234	N	02242	W	02250
F	02235	O	00206	X	02011
G	02236	P	02244	Y	02012
H	02237	Q	02245	Z	02013
I	02238	R	02246		

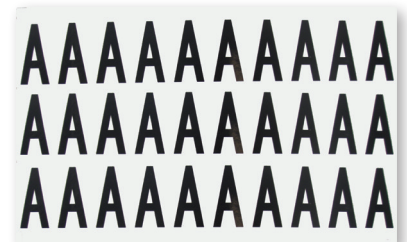

Sheet of 30 adhesive-backed, stick-on labels, RED on white

Letter	ARS Code
S	00543



Edge sealant

Description	Unit of Measure	ARS Code
Edge sealant	Each	00165



Joins & Terminations

Kiosk Terminations for 240mm² 4C AL XLPE



Description	Unit of Measure	ARS Code
ENDLVSUB TERM, 240mm AL XLPE CAT 1 - 1-hole lugs for active phases	Kit	A0004
ENDLVSUB TERM, 240mm AL XLPE CAT 2 - 2-hole lugs for active phases	Kit	A0005

Fuses

Description	Unit of Measure	ARS Code
Fuse, Link Cartridge 100A 500V DIN 2 IN	Each	00805
Fuse, Link Cartridge 160A 500V DIN 2 IN	Each	03330
Fuse, Link Cartridge 200A 500V DIN 2 IN	Each	02828
Fuse, Link Cartridge 250A 500V DIN 2 IN	Each	00600
Fuse, Link Cartridge 315A 500V DIN 2 IN	Each	02809
Fuse, Link Cartridge 400A 500V DIN 2 IN	Each	00599

Joins for 240mm² 4C AL XLPE

Heatshrink joint kit

Description	Unit of Measure	ARS Code
STJ, LV 150-300 4c XLPE - comes with links END	Each	08132
STJ, LV 240 AL XLPE/XLPE - comes with crimp links	Kit	A0033
STJ, LV 240 XLPE/XLPE - no links	Each	00010



Endeavour LV Underground

UG/OH TERMINATIONS (ON WOOD POLE)

Underground Cable	Overhead Mains Cable			
	Bare Al/Cu	1 x 4c 95 ABC	2 x 4c 95 ABC	1 x 4c 150 ABC
240mm ² 4c Al	A0618 Excludes bonding	A0037 Includes tails A0069 Excludes tails	A0925 Includes tails	A0351 Includes tails A0720 Excludes tails

PILLARS WITHOUT OPEN POINT

Underground Cable	Pillar Termination Type			
	Service	1 Mains Cable	2 Mains Cables	3 Mains Cables
50mm ² 4c Cu	A1070	N/A	N/A	N/A
240mm ² 4c Al	N/A	A1056	A1057	A1058

PILLARS WITH OPEN POINT

Underground Cable	Pillar Termination Type		
	2 Way	3 Way (Residential)	3 Way (Industrial)
240mm ² 4c Al	A1059 Single Link	A1229 Triple Link	A1061 Double Link

Quick Reference Tables

SUBSTATION TERMINATIONS

Underground Cable	Termination Type	
	CAT 1	CAT 2
240mm ² 4c Al	A0004	A0005

INLINE JOINT KIT

Underground Cable	240mm ² 4c Al
240mm ² 4c Al	00010 No links or connectors
240mm ² 4c Al	08132 Includes Mechanical Connectors
240mm ² 4c Al	A0033 With Compression Links

Individual components

Pillars & bases

Description	Unit of Measure	ARS Code
PILLAR BOX, SMALL VENTED GREEN RECTANGULAR	Each	00032
PILLAR BOX, LARGE VENTED GREEN RECTANGULAR	Each	00025
PILLAR BOX, XL VENTED GREEN RECTANGLAR	Each	07254
PILLAR BASE, GREEN MOULDED PLASTIC	Each	00094
PILLAR BASE, GREEN MOULDED PLASTIC-WIDE	Each	04553
BOLT, D-BOLT URD PILLAR M10 X 30MM SS	Each	00027



Pillar termination kits

Description	Unit of Measure	ARS Code
TERM,LV 240 AL XLPE (URD 1 MAINS) LUGS	Each	00083
TERM,LV 240 AL XLPE (URD 2 MAINS) LUGS	Each	00084
TERM,LV 240 AL XLPE (URD 3 MAINS) LUGS	Each	00085
TERM, 2-WAY SINGLE LINK ENDEAVOUR	Each	00086
TERM, 3-WAY TRIPLE LINK ENDEAVOUR - RES	Each	09077
SUPPORT KIT, 3-WAY TRIPLE LINK TERM	Each	09166
TERM, 3-WAY DOUBLE LINK ENDEAVOUR - C/I	Each	02390



Terminal blocks

Description	Unit of Measure	ARS Code
TERMINAL BLOCK, 3 HOLE 50MM2	Each	00012
TERMINAL BLOCK, 6 HOLE 50MM2	Each	00028
CAP, 3 HOLE TERMINAL BLOCK YELLOW SL ID	Each	05755
CAP, 6 HOLE TERMINAL BLOCK YELLOW SL ID	Each	05756



Heatshrink breakouts

Description	Unit of Measure	ARS Code
HEATSHRINK,GLOVE 4 F 4-35 BLACK LINED	Each	03132
HEATSHRINK,GLOVE 4 F 35-70 BLACK LINED	Each	03133
HEATSHRINK,GLOVE 4 F 70-150 BLACK LINED	Each	02973
HEATSHRINK,GLOVE 4 F 185-300 BLACK LINED	Each	00050



Heatshrink end caps

Description	Unit of Measure	ARS Code
HEATSHRINK,END CAP 4-8 OD BLK LIN	Each	04072
HEATSHRINK,END CAP 8-17 OD BLK LIN	Each	02646
HEATSHRINK,END CAP 17-30 OD BLK LIN	Each	02194
HEATSHRINK,END CAP 30-45 OD BLK LIN	Each	02422
HEATSHRINK,END CAP 45- 65 OD BLK LIN	Each	00197
HEATSHRINK,END CAP 65-95 OD BLK LIN	Each	02496
HEATSHRINK,END CAP 95-115 OD BLK LIN	Each	05034



Heatshrink tubing – no adhesive (thin wall)

Description	Unit of Measure	ARS Code
HEATSHRINK,TUBE LV 25/12TW RED UNL 1.2M	Each	06807
HEATSHRINK,TUBE LV 25/12TW WHT UNL 1.2M	Each	06808
HEATSHRINK,TUBE LV 25/12TW BLU UNL 1.2M	Each	06809
HEATSHRINK,TUBE LV 25/12TW BLK UNL 1.2M	Each	06810
HEATSHRINK,TUBE LV 40/20TW RED UNL 1.2M	Each	03371
HEATSHRINK,TUBE LV 40/20TW WHT UNL 1.2M	Each	03372
HEATSHRINK,TUBE LV 40/20TW BLU UNL 1.2M	Each	03373
HEATSHRINK,TUBE LV 40/20TW BLK UNL 1.2M	Each	03370
HEATSHRINK,TUBE LV 8/4TW G/Y UNL 1.2M	Each	06803
HEATSHRINK,TUBE LV 10/5TW G/Y UNL 1.2M	Each	06804
HEATSHRINK,TUBE LV 12/6TW G/Y UNL 1.2M	Each	06805
HEATSHRINK,TUBE LV 20/10TW G/Y UNL 1.2M	Each	06806

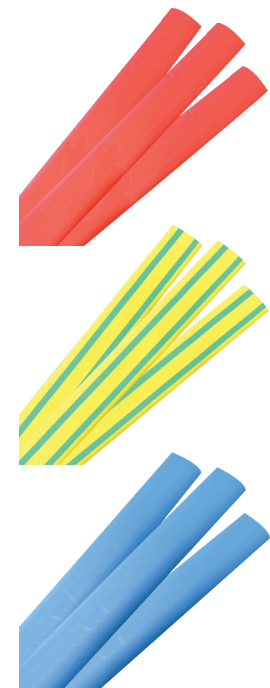

Heatshrink tubing – no adhesive (medium wall)

Description	Unit of Measure	ARS Code
HEATSHRINK,TUBE LV 10/3MW BLK UNL 40M	Each	08179
HEATSHRINK,TUBE LV 16/5MW BLK UNL 40M	Each	08176
HEATSHRINK,TUBE LV 25/8MW BLK UNL 40M	Each	08178
HEATSHRINK,TUBE LV 35/12MW BLK UNL 30M	Each	08174
HEATSHRINK,TUBE LV 50/16MW BLK UNL 25M	Each	08171
HEATSHRINK,TUBE LV 63/19MW BLK UNL 15M	Each	08180
HEATSHRINK,TUBE LV 85/25MW BLK UNL 60M	Each	06416



Heatshrink tubing – adhesive lined (medium wall)

Description	Unit of Measure	ARS Code
HEATSHRINK,TUBE LV 10/3MW BLK LND 1.2M	Each	02301
HEATSHRINK,TUBE LV 16/5MW BLK LND 1.2M	Each	00006
HEATSHRINK,TUBE LV 25/8MW BLK LND 1.2M	Each	03379
HEATSHRINK,TUBE LV 35/12MW BLK LND 1.2M	Each	00318
HEATSHRINK,TUBE LV 50/16MW BLK LND 1.2M	Each	00129
HEATSHRINK,TUBE LV 63/19MW BLK LND 1.2M	Each	00547
HEATSHRINK,TUBE LV 85/25MW BLK LND 1.2M	Each	04936
HEATSHRINK,TUBE LV 115/34MW BLK LND 1.2M	Each	02318
HEATSHRINK,TUBE LV 140/42MW BLK LND 1.5M	Each	04892
HEATSHRINK,TUBE LV 160/50MW BLK LND 1.2M	Each	06771



Heatshrink tubing – adhesive lined (heavy wall)

Description	Unit of Measure	ARS Code
HEATSHRINK,TUBE LV 24/6HW BLK LND 1.2M	Each	04945
HEATSHRINK,TUBE LV 33/8HW BLK LND 1.2M	Each	04902
HEATSHRINK,TUBE LV 48/12HW BLK LND 1.2M	Each	03380
HEATSHRINK,TUBE LV 56/16HW BLK LND 1.2M	Each	04067
HEATSHRINK,TUBE LV 70/21HW BLK LND 1.2M	Each	04068
HEATSHRINK,TUBE LV 90/25HW BLK LND 1.2M	Each	04069
HEATSHRINK,TUBE LV 110/30HW BLK LND 1M	Each	04070
HEATSHRINK,TUBE LV 130/36HW BLK LND 1.2M	Each	03979
HEATSHRINK,TUBE LV 160/50HW BLK LND 1M	Each	06831



Copper compression lugs

Description	Unit of Measure	ARS Code
LUG, COMP 16 CU M12 1 HOLE	Each	00128
LUG, COMP 25 CU M12 1 HOLE	Each	00015
LUG, COMP 35 CU M12 1 HOLE	Each	02077
LUG, COMP 50 CU M12 1 HOLE	Each	00127
LUG, COMP 70 CU M12 1 HOLE	Each	00016
LUG, COMP 95 CU M12 1 HOLE	Each	00152
LUG, COMP 120 CU M12 1 HOLE	Each	00148
LUG, COMP 150 CU M12 1 HOLE	Each	02978
LUG, COMP 185 CU M12 1 HOLE	Each	02217
LUG, COMP 240 CU M12 1 HOLE	Each	00144



Aluminium compression lugs

Description	Unit of Measure	ARS Code
LUG, COMP 240 AL M12 1 HOLE	Each	02290
LUG, COMP 240 AL M12 2 HOLE	Each	00132



Cable clamp kit (suits 240mm² 4c XLPE cable)

Description	Unit of Measure	ARS Code
CABLE CLAMP KIT, CABLE 50-75 PLASTIC	Kit	A0074
NITRILE RUBBER SHEET 200 X 150 X 3	Each	03378



Cable saddle (suits 240mm² 4c XLPE cable)

Description	Unit of Measure	ARS Code
SADDLE, 60MM TYPE 3 GALV STEEL	Each	00234



Pole cover guard

Description	Unit of Measure	ARS Code
COVER GUARD, POLE PLASTIC BLK SGL 1.55M	Each	02713



Conduit – lengths

Description	DTS Code	Gated Code
CONDUIT, 40MM X 4M HD ORANGE SMOOTH	00041	00041G
CONDUIT, 50MM X 4M HD ORANGE SMOOTH	00185	00185G
CONDUIT, 125MM X 4M HD ORANGE SMOOTH	02042	02042G
CONDUIT, 125MM X 6M LD ORANGE SMOOTH	00106	00106G



Conduit – end caps

Description	DTS Code	Gated Code
CONDUIT END CAP, 40MM RED	Each	00103
CONDUIT END CAP, 50MM RED	Each	02051
CONDUIT END CAP, 125MM BLACK	Each	00818



Conduit – bends

Description	Unit of Measure	ARS Code
BEND, 40MM 45 DEGREE 300R HD ORANGE	Each	08772
BEND, 40MM 90 DEGREE "HOCKEY STICK" HD ORANGE	Each	08771
BEND, 40MM 90 DEGREE 300R HD ORANGE	Each	08773
BEND, 50MM 90 DEGREE 300R HD ORANGE	Each	08774
BEND, 125MM 22.5 DEGREE 635R HD ORANGE	Each	TBA
BEND, 125MM 22.5 DEGREE 1200R HD ORANGE	Each	08803
BEND, 125MM 45 DEGREE 600R HD ORANGE	Each	02043
BEND, 125MM 45 DEGREE 1200R HD ORANGE	Each	08804
BEND, 125MM 45 DEGREE 1830R HD ORANGE	Each	08781
BEND, 125MM 90 DEGREE 1830R HD ORANGE	Each	08776



Conduit – bell mouths

Description	Unit of Measure	ARS Code
BELL MOUTH, 50MM HD	Each	02817
BELL MOUTH, 125MM HD	Each	02767



Conduit – accessories

Description	Unit of Measure	ARS Code
CONDUIT GLUE, 500ML	Each	02078
CONDUIT GLUE, 4L	Each	02546
JETLINE, 90KG, 1830M	Each	04590
JETLINE, 163KG, 950M	Each	04591
PARAMATTA ROPE, 6MM, 400M	Each	03460
CABLE PULLING LUBE, TYPE G, BLUE, 1L	Each	02181
CABLE PULLING LUBE, TYPE C, GREEN, 10L	Each	02768



Street light items

Description	Unit of Measure	ARS Code
SHEET, INSULATING WRAP STREETLIGHT COLUMN	Each	00038
CAP, 3 HOLE TERMINAL BLOCK YELLOW SL ID	Each	05755
CAP, 6 HOLE TERMINAL BLOCK YELLOW SL ID	Each	05756
FUSE HOLDER, VERTICAL WITH TAIL FOR SL	Each	05995
FUSE, BOTTLE, NEOZED D001 10A	Each	06315
FUSE, BOTTLE, NEOZED D001 16A	Each	02654



Conduit – accessories

Description	Unit of Measure	ARS Code
GLOVES, 1000V ELECTRICIAN SIZE 8 - YELLOW	Pair	08458
GLOVES, 1000V ELECTRICIAN SIZE 9 - YELLOW	Pair	08459
GLOVES, 1000V ELECTRICIAN SIZE 10 - YELLOW	Pair	08460
GLOVES, 1000V ELECTRICIAN SIZE 11 - YELLOW	Pair	08461



Cotton inner gloves

Description	Unit of Measure	ARS Code
GLOVE, KNITTED COTTON BEIGE, INNER LINER	Pair	08452
GLOVE, COTTON INTERLOCK WHITE, INNER LINER	Pair	03622



Leather outer gloves

Description	Unit of Measure	ARS Code
GLOVE, GOATSKIN OUTER, 250MM – SIZE 8	Pair	08452
GLOVE, GOATSKIN OUTER, 250MM – SIZE 9	Pair	08453
GLOVE, GOATSKIN OUTER, 250MM – SIZE 10	Pair	08454
GLOVE, GOATSKIN OUTER, 250MM – SIZE 11	Pair	08455



Glove accessories

Description	Unit of Measure	ARS Code
GLOVE BAG, SINGLE POCKET, CANVAS, VELCRO	Each	08449
GLOVE BAG, DOUBLE POCKET, CANVAS, VELCRO	Each	08450
GLOVE TALC, 100G	Each	06823
GLOVE AIR CHECK TOOL	Each	08719



Low voltage rescue kit

Description	Unit of Measure	ARS Code
RESCUE KIT, LOW VOLTAGE, SOFT BAG W/GLOVES	Each	08888



Low voltage rescue kit

Description	Unit of Measure	ARS Code
KIT, STREETLIGHT POLE - FULL	Kit	05740
KIT, STREETLIGHT POLE - NO MAT	Kit	05741



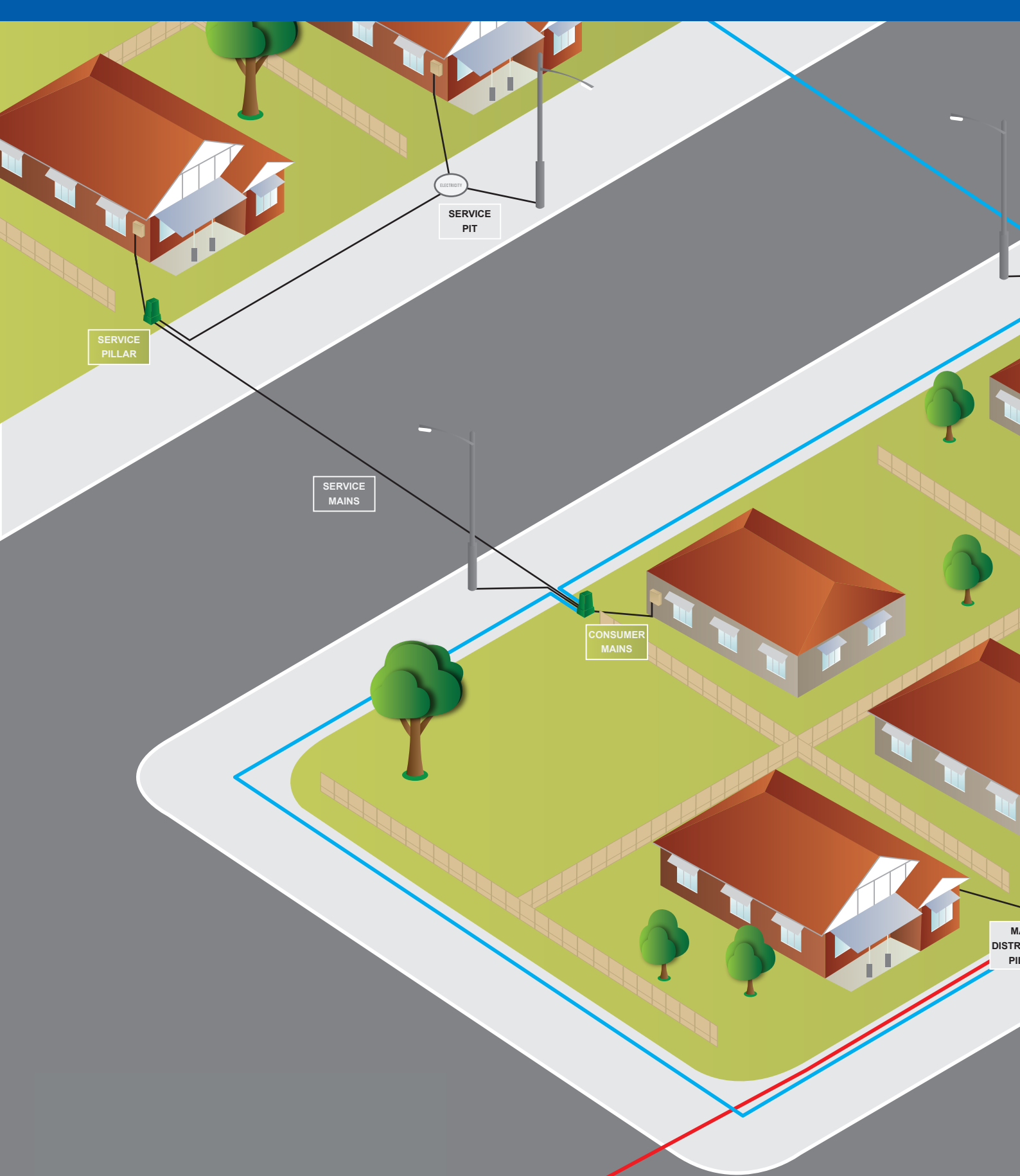

Typical utility underground network

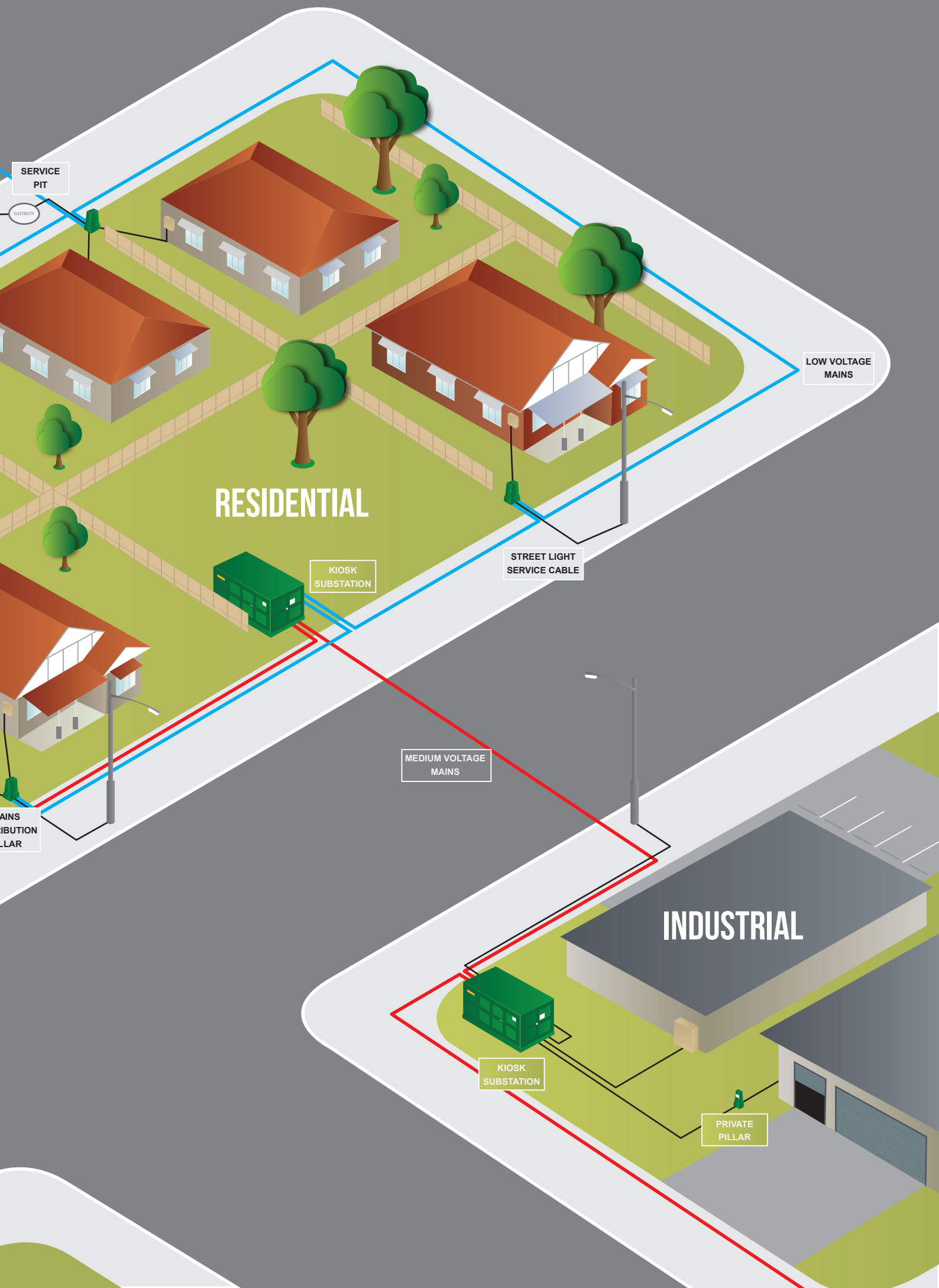

SERVICE PIT

ELECTRICITY

LOW VOLTAGE MAINS

RESIDENTIAL

KIOSK SUBSTATION

STREET LIGHT SERVICE CABLE

MEDIUM VOLTAGE MAINS

MAINS DISTRIBUTION PILLAR

INDUSTRIAL

KIOSK SUBSTATION

PRIVATE PILLAR

All Round Supplies
13 Progress Circuit,
Prestons, NSW, 2170

P 1300 087 579
E sales@ars.com.au
W ars.com.au



**All Round
Supplies®**